

## 1.0 Installing SSPS on a HyTronic® Faucet

Thank you for purchasing the Chicago Faucets Self-Sustaining Power Supply (SSPS). All Chicago Faucets products are carefully assembled and tested to insure the highest quality in the plumbing industry. We are proud to offer you a product that will provide years of dependable, reliable service.

*Note: This user guide is a supplement to the faucet user guide. For instructions on how to install, service, and maintain the faucet, please refer to the faucet user guide.*



## Self-Sustaining Power Supply User Guide

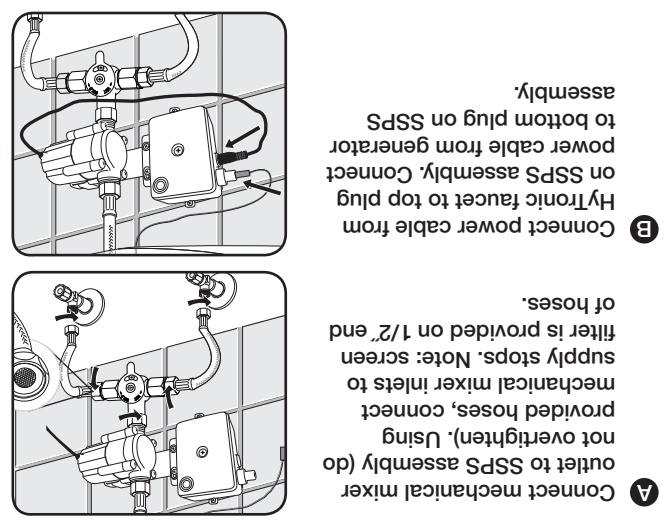

Product Model Numbers:  
116.901.AB.1, 116.902.AB.1, 116.903.AB.1, 119.904.AB.1 or 116.905.AB.1

## 1.1 HyTronic® Faucets with SSPS For Single Water Supply Use

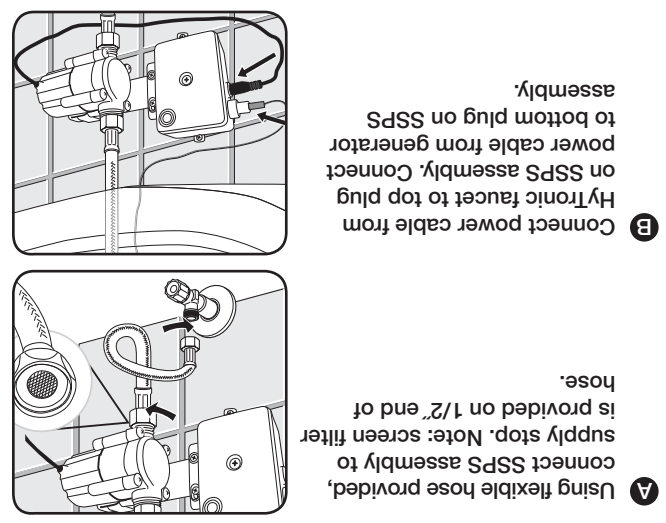

Product Model Numbers:  
116.911.AB.1 or 116.912.AB.1, 116.913.AB.1 or 119.914.AB.1 or 116.915.AB.1

## 1.2 HyTronic® Faucets with SSPS and Mechanical Mixer



Product Model Numbers:  
116.921.AB.1 or 116.922.AB.1 or 116.923.AB.1 or 119.924.AB.1 or 116.925.AB.1

## 1.3 HyTronic® Faucets with SSPS & 131 Series Thermostatic Mixer

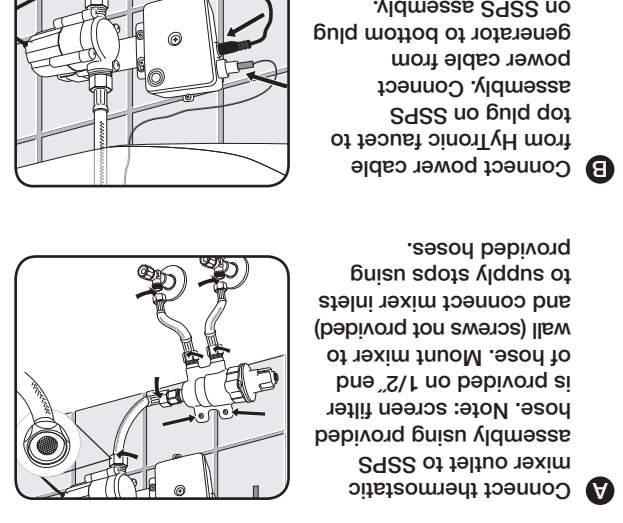

After mounting the SSPS (see section 1.0), please proceed as follows:

## Safety Information

Read this entire user guide to ensure proper installation. Compliance and conformity to local codes and ordinances is the responsibility of the installer. The following safety notes must always be complied with during handling of this product:

- Make sure there is enough space and lighting available during installation and service.
- Do not modify or convert this Chicago Faucets product yourself. All warranties will be voided.

### IMPORTANT

- Installation may be performed at different times of construction by different individuals. For this reason, these instructions should be left on-site with the facility or maintenance manager.
- Pressurized plumbing fittings shall be installed in accordance with manufacturer's recommendations. The supply piping to these devices shall be securely anchored to the building structure to prevent installed device from unnecessary movement when operated by the user. Care shall be exercised when installing the device to prevent marring the exposed significant surface.
- Do not use pipe dope.
- Flush all the water supply lines before making connections.



The Chicago Faucet Company  
2100 South Clearwater Drive  
Des Plaines, IL 60018  
Phone: 847/803-5000  
Fax: 847/803-5454  
Technical: 800/832-8783  
www.chicagofaucets.com

2.0

## Installing SSPS on an E-Tronic® 40 Faucet

- 1 Remove outlet adaptor.

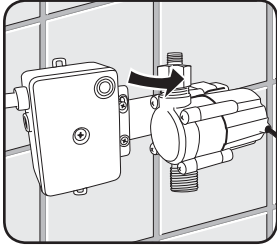

- 2 Using provided hose, attach faucet inlet shank to SSPS assembly outlet. Do not overtighten connection to SSPS assembly.

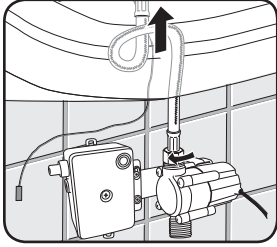

- 3 Mount SSPS assembly to wall using tabs on top and bottom of housing (mounting screws not provided).

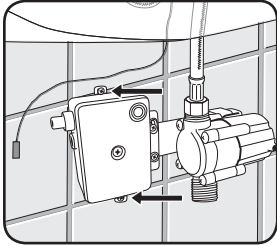

2.1

## E-Tronic® 40 Faucets with SSPS For Single Water Supply Use

Product Model Numbers:  
116.906.AB.1

After mounting the SSPS (see section 2.0), please proceed as follows:

- A Using flexible hose provided, connect SSPS assembly to supply stop. Note: screen filter is provided on 1/2" end of hose.

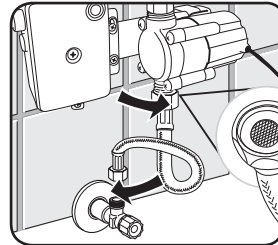

- B Connect power cable from E-Tronic 40 faucet to top plug on SSPS assembly. Connect power cable from generator to bottom plug on SSPS assembly.

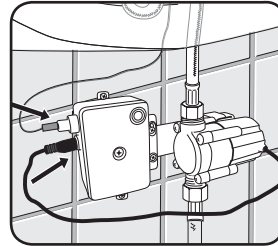

2.2

## E-Tronic® 40 Faucets with SSPS and Mechanical Mixer

Product Model Numbers:  
116.916.AB.1

After mounting the SSPS (see section 2.0), please proceed as follows:

- A Connect mechanical mixer outlet to SSPS assembly (do not overtighten). Using provided hoses, connect mechanical mixer inlets to supply stops. Note: screen filter is provided on 1/2" end of hoses.

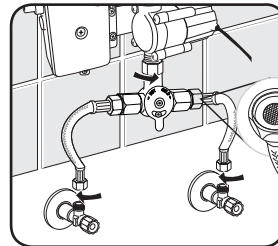

- B Connect power cable from E-Tronic 40 faucet to top plug on SSPS assembly. Connect power cable from generator to bottom plug on SSPS assembly.

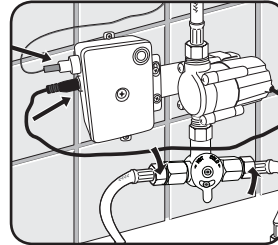

3.0

## Spare Parts

**CHICAGO FAUCETS**  
a Geberit company

For additional faucet spare parts refer to the Faucet User Guide.

**Description** **CFC Part Number**

SSPS Assembly 242.566.AB.1

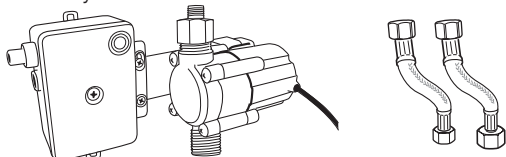

HyTronic® Electronic Module Kit (includes Electronic Module and Green Adapter Holder Assembly) 242.574.00.1

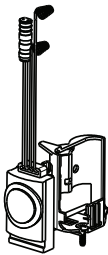

E-Tronic® 40 Electronic Module Kit (includes Electronic Module and Green Adapter Holder Assembly) 242.575.00.1

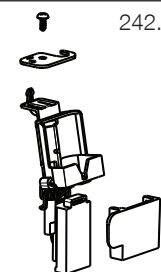

**Lavatory Fittings**



E28JKCP

Vandal-Proof Pressure Compensating Econo-Flo Spray Outlet, 1.0 GPM (3.8L/min) max. flow at 60 PSI

**Gooseneck Fittings**



E28-5JKCP

Vandal-Proof Pressure Compensating Econo-Flo Spray Outlet, 1.0 GPM (3.8L/min) max. flow at 60 PSI

**Gooseneck FC Fittings**

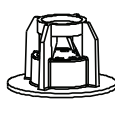

1020-034KJKNF

1.0 GPM Pressure Compensating Flow Control (located in spout base)

Green Power Adapter 242.568.00.1



4.0

## Retrofitting the SSPS

If you currently own a battery powered HyTronic or E-Tronic faucet and you've purchased the SSPS to retrofit the product please follow these instructions.

*Note: In order to comply with current Codes and Standards the following has to be addressed when retrofitting the SSPS to existing products.*

### Conversion Overview

- 1.0 A minimum flow rate is required for power generation. See Section 3.0 for recommended outlets.
- 2.0 The electronic module has to be set to a maximum run time of 10 seconds by using the Geberit Commander™ software and adjusting the faucet to water saver or metering mode of 10 seconds. If you cannot make this adjustment, you must purchase the appropriate electronic module kit for your faucet (reference Section 3.0 for correct part number).
- 3.0 A Green Power Adapter must be purchased to allow power distribution from the SSPS to the faucet. (reference Section 3.0 for correct part number).

### Conversion Steps:

- 1.0 Re-program the electronic module to water saver or metering mode with maximum run time of 10 seconds.  
*\* If re-programming is not desired, you must use the appropriate electronic module kit.*
- 2.0 Remove the spout screw and lift the spout.
- 3.0 Remove the battery from the battery holder.
- 4.0 Disconnect the power connection to the solenoid.
- 5.0 Remove the electronic module and battery holder assembly.
- 6.0 Loosen the faucet from the deck. Ensure that the faucet can be lifted from the deck to allow for the next steps.
- 7.0 Insert the Green Power Adapter into the battery holder and route the wire through the faucet valve body below the deck.
- 8.0 Re-install the electronic module and battery holder with Green Power Adapter back into the faucet.
- 9.0 Re-connect the solenoid assembly.
- 10.0 Replace the spout and holding screw.
- 11.0 Replace the faucet outlet with a recommended outlet as listed in Section 3.0.
- 12.0 Install the SSPS by following the appropriate instructions for your faucet model, as outlined in this User Guide.

2.3

## E-Tronic® 40 Faucets with SSPS & 131 Series Thermostatic Mixer

Product Model Numbers:  
116.926.AB.1

After mounting the SSPS (see section 2.0), please proceed as follows:

- A Connect thermostatic mixer outlet to SSPS assembly using provided hose. Note: screen filter is provided on 1/2" end of hose. Mount mixer to wall (screws not provided) and connect mixer inlets to supply stops using provided hoses.

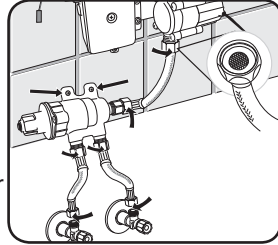

- B Connect power cable from E-Tronic 40 faucet to top plug on SSPS assembly. Connect power cable from generator to bottom plug on SSPS assembly.

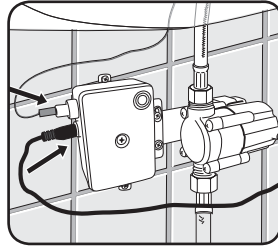

## Limited Warranty

The CHICAGO FAUCET COMPANY ("Chicago Faucets") extends to the original consumer the following warranties for Genuine Chicago Faucets manufactured products and components, or other components under the Chicago Faucets Warranties, (collectively, the "Products").

**Lifetime Faucet Warranty** The "Faucet", defined as any metal cast, forged, stamped or formed portion of the Product, not including electronic or moving parts or water restricting components, or other components covered under the Chicago Faucet warranties, is warranted against defects for the life of the product.

**One Year Finish Warranty** The finish of the Product is warranted against manufacturing defects for a period of one (1) year from the date of Product purchase.

**Electronic Faucets Mechanicals Warranty** Are warranted for five (5) years from the date of installation.

**Electronic Faucets Finishes Warranty** Are warranted for one-year from the date of installation.

**Electronic Faucets Electronics and Solenoid Warranty** Are warranted for three (3) years from the date of installation.