

MECHANICAL FAUCETS

613-AL15E1CP

Pre-Rinse Fittings



Product Type

Deck Mounted Single Hole Adapta-Faucet

Features & Specifications

- Single Hole
- Full Flow Outlet
- 2-3/8" Vandal Proof Lever
- Quatern
- 1 1/16" - 18 UNEF Female Thread Inlet
- 3/8" NPT Female Outlet in Tee

Performance Specification

- Rated Operating Pressure: 20-125 PSI
- Rated Operating Temperature: 40-140°F

Warranty

- Lifetime Limited Faucet Warranty
- 5-Year Limited Cartridge Warranty
- 1-Year Limited Finish Warranty

Codes & Standards

- ASME A112.18.1/CSA B125.1
- Certified to NSF/ANSI 61, Section 9 by CSA
- ADA ANSI/ICC A117.1

Job Name _____

Item Number _____

Section/Tag _____

Model Specified _____

Architect _____

Engineer _____

Contractor _____

Submitted as Shown Submitted with Variations

Date _____



2100 South Clearwater Drive
Des Plaines, IL
P: 847/803-5000
F: 847/803-5454
Technical: 800/TEC-TRUE
www.chicagofaucets.com

613-AL15E1CP

Pre-Rinse Fittings



Architect/Engineer Specification

Chicago Faucets No. 613-AL15E1CP, Adapta-Faucet, single-hole deck mount, chrome plated. L-Type swing spout, 14" center-to-center. Full-flow Quixtop outlet with single-screen design. 2-3/8" metal, vandal-proof lever handle with sixteen-point, tapered broach and secured, white index button. Quatum™ rebuildable compression cartridge, opens and closes 90°, closes with water pressure, features square, tapered stem. 1-1/16"-18 UNEF female thread inlet. 3/8" NPT female outlet in tee. This product meets ADA ANSI/ICC A117.1 requirements and is tested and certified to industry standards: ASME A112.18.1/CSA B125.1, and Certified to NSF/ANSI 61, Section 9 by CSA.

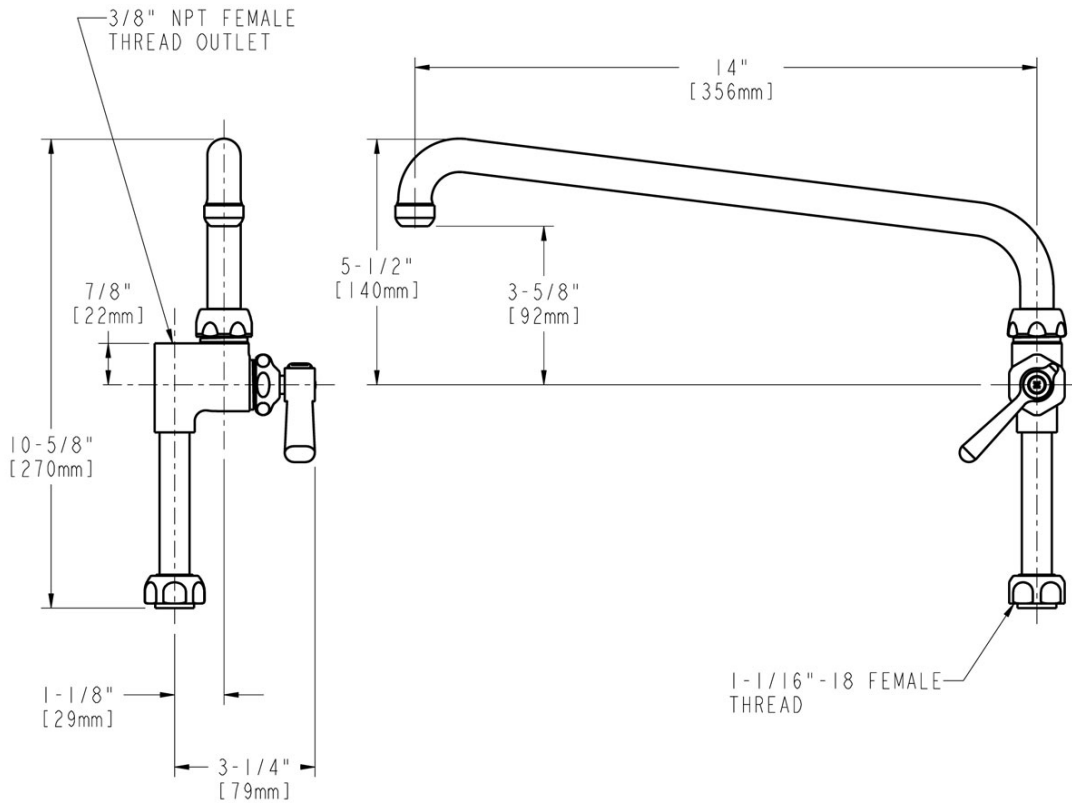

Operation and Maintenance

Installation should be in accordance with local plumbing codes. Flush all pipes thoroughly before installation. After installation, remove spout outlet or flow control and flush faucet thoroughly to clear any debris. Care should be taken when cleaning the product. Do not use abrasive cleaners, chemicals or solvents as they can result in surface damage. Use mild soap and warm water for cleaning and protecting the life of Chicago Faucet products. For specific operation and maintenance refer to the installation instructions and repair parts documents that are located at www.chicagofaucets.com.

Chicago Faucets, member of the Geberit Group, is the leading brand of commercial faucets and fittings in the United States, offering a complete range of products for schools, laboratories, hospitals, office buildings, food service, airports and sport facilities. Call 1.800.TECTRUE or 1.847.803.5000 Option 1 for installation or other technical assistance.



2100 South Clearwater Drive
Des Plaines, IL
P: 847/803-5000
F: 847/803-5454
Technical: 800/TEC-TRUE
www.chicagofaucets.com